

NOTES: UNLESS OTHERWISE SPECIFIED

- CORNERS DRAWN SHARP TO BE R.005 MAXIMUM.
- EXTERIOR SURFACE TEXTURE TO BE EDM FINISH. EQUIVALENT TO MT-11020. TEXTURE ON ENCLOSURE WILL VARY FROM TIME TO TIME AS THE TOOL WEARS AND IT BECOMES NECESSARY TO REAPPLY.
- INTERIOR SURFACE TEXTURE TO BE: NONE.
- ALL INSIDE RADII .010R. UNLESS OTHERWISE SPECIFIED.
- ALL EXTERNAL DIMENSIONS AFFECTED BY THE DRAFT APPLY AT THE LARGE END OF THE FEATURE, AND ALL INTERNAL FEATURES AFFECTED BY THE DRAFT APPLY AT THE SMALL END OF THE FEATURE UNLESS OTHERWISE SPECIFIED.
- 1 DEGREE DRAFT IN THE DIRECTION OF PULL IS PERMISSIBLE UNLESS OTHERWISE SPECIFIED.
- MATERIAL / COLOR: ABS PLASTIC IS STANDARD IN BLACK OR WHITE. CUSTOM MATERIALS AND COLORS ARE AVAILABLE UPON REQUEST FOR QUOTE. ALTERNATE RESINS HAVE DIFFERENT SHRINK RATES, AND WILL EFFECT DIMENSIONS.
- PCB SIZES ARE RECOMMENDATIONS ONLY. FINAL SIZES AND VERIFICATION OF ITS FIT ARE THE SOLE RESPONSIBILITY OF EACH CUSTOMER.
- ASSEMBLY SCREWS FOR THE ENCLOSURE INCLUDED. MOUNTING SCREWS FOR THE WALL SOLD SEPERATELY.
- THIS DRAWING IS BASED ON A SOLID MODEL, AND IS FURTHER DEFINED BY THE SOLID MODEL FILE.
- ALLOWABLE FLASH: 0.010 MAX.
- ALL EJECTOR PIN MARKS TO BE WITHIN 0.010" OF FLUSH, PROTRUDING OR BELOW FLUSH.
- TRIM GATE WITHIN 0.030" OF FLUSH.

R E V I S I O N					DATE	APPROVED
REV.	DRAWN BY	ECO No	DESCRIPTION			
A	M BOYER	DR XXX	PRELIMINARY RELEASE		2016-Mar-14	

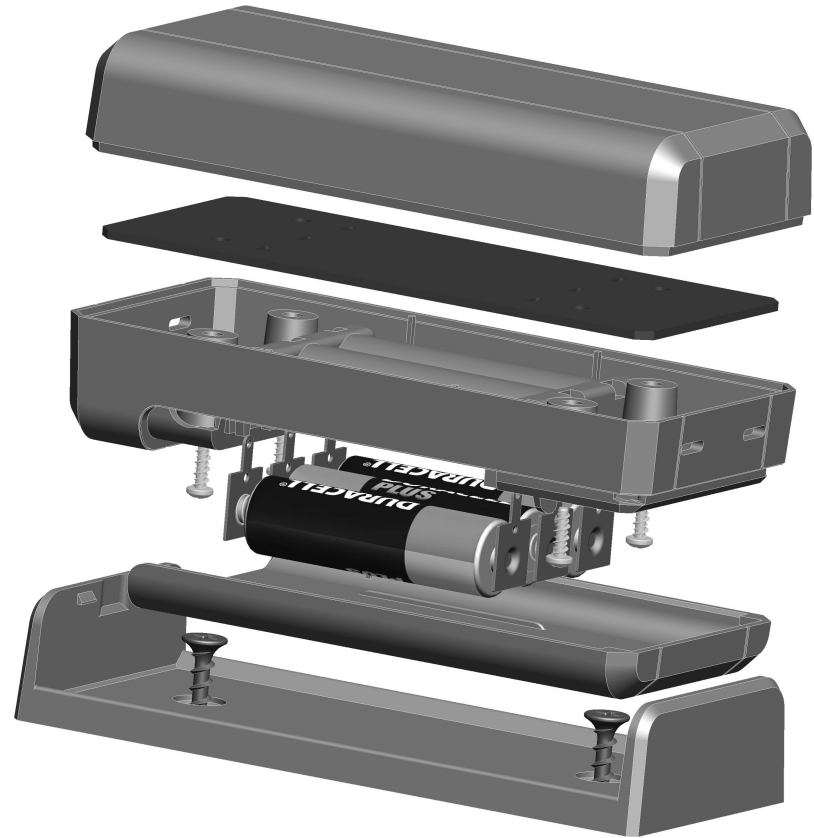

SCALE 0.750

472216(x) CONFIGURATIONS		
	[Blank]	-W
472216 COVER	1	
472216 BASE	1	
472216 HATCH	1	
472216 WALL PLATE		1
472216 PCB	1*	
#4 HILO SCREW .375"	4	

ITEM	FILE NAME	DESCRIPTION	MATERIAL	COLOR	QTY.
10	AA-SINGL-CONTACT-POS	ACC-AAPOS-5223	SPRING STEEL		3
9	AA-SINGL-CONTACT-NEG	ACC-AANEG-5201	SPRING STEEL		3
8	SCREW-DRYWALLX750	DRYWALL SCREW - REFERENCE	CUSTOMER SUPPLIED		2
7	AA-BATTERY	"AA" SIZE BATTERY	REFERENCE		3
6	472216-PCB	472216 PCB - REFERENCE	.062" THICK		1
5	472216-WALL	472216 WALL - STANDARD	ABS	BLACK or WHITE	1
4	472216-HATCH	472216 HATCH - STANDARD	ABS	BLACK or WHITE	1
3	472216-COVER	472216 COVER - STANDARD	ABS	BLACK or WHITE	1
2	472216-BASE	472216 BASE - STANDARD	ABS	BLACK or WHITE	1
1	NO4_HI-LO	ASSEMBLY & PCB	No4 HILO x 3/8"		4 INCLUDED

BILL OF MATERIALS

THIRD ANGLE PROJECTION	TOLERANCES: UNLESS OTHERWISE SPECIFIED DIMENSIONS ARE IN U.S. INCHES. X.XX = .015 X.XXXX = .001 X.XXX = .010 X.X" = 1°
DO NOT SCALE DRAWING	NEW AGE ENCLOSURES
NOTICE: THE INFORMATION AND DATA CONTAINED HEREIN IS CONSIDERED PROPRIETARY TO ALLTEC INTEGRATED MFG INC & SHALL REMAIN THE EXCLUSIVE PROPERTY OF ALLTEC INTEGRATED MFG INC. THE HOLDER WILL ASSUME CUSTODY AND CONTROL THAT THIS DOCUMENT WILL NOT BE COPIED, REPRODUCED, OR DISCLOSED WITHOUT THE EXPRESS WRITTEN CONSENT OF ALLTEC INTEGRATED MFG INC. THIS DOCUMENT DOES NOT CONSTITUTE A GRANT TO MANUFACTURE ANY ITEMS. © 2016	Customer's Part No: 472216
APPROVAL	BY DATE
CHECK	
ENG.	
SCALE	AS NOTED
DRAWN BY	SIZE
M BOYER	A
2016-Mar-14	DRAWING NAME
	472216_RA

NEW AGE ENCLOSURES
 4330 Santa Fe Road San Luis Obispo, CA. 93401
 ph. (805) 595-1310 fax (805) 595-1024
www.newageenclosures.com

MEDIUM 3 AA - STANDARD
SXX-472216-XXX

SHEET	REV.DOC
1 OF 8	A

472216 ASSEMBLY

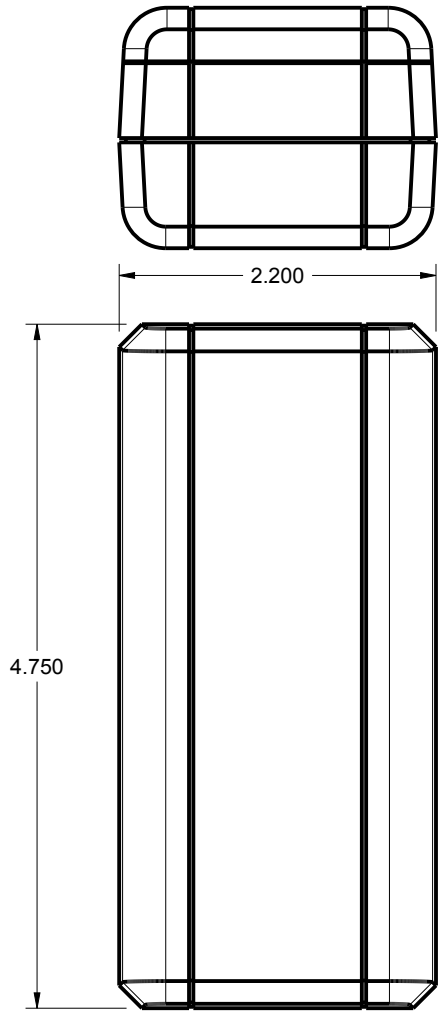

SCALE 0.750

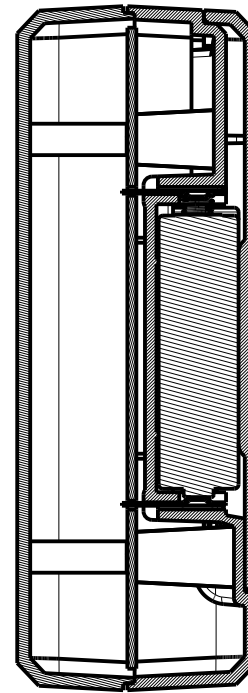
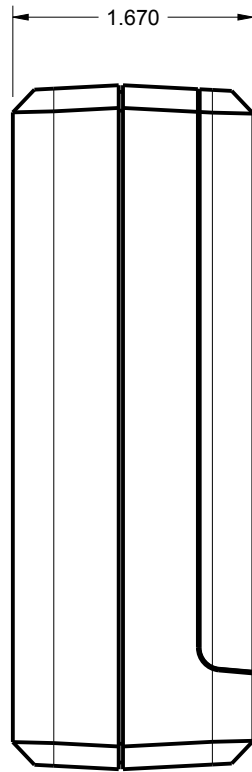

SECTION X-X

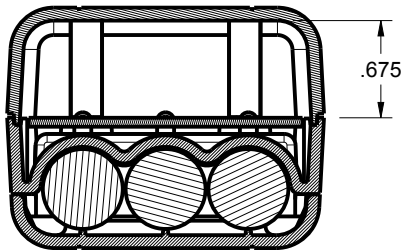
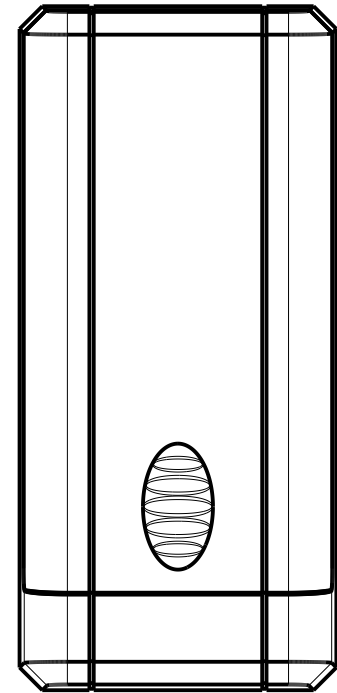

SECTION Y-Y

TOLERANCES: UNLESS OTHERWISE SPECIFIED
DIMENSIONS ARE IN U.S. INCHES.
X.XX = .015 X.XXXX = .001
X.XXX = .010 X.X° = 1°

NEW AGE ENCLOSURES

Customer's Part No: 472216

APPROVAL BY DATE

CHECK

ENG.

SCALE AS NOTED

DRAWN BY M BOYER 2016-Mar-14

NEW AGE ENCLOSURES

4330 Santa Fe Road San Luis Obispo, CA. 93401
ph. (805) 595-1310 fax (805) 595-1024
www.newageenclosures.com

MEDIUM 3 AA - STANDARD
SXX-472216-XXX

SIZE A DRAWING NAME 472216_RA

SHEET 2 OF 8 REV.DOC A

472216 COVER

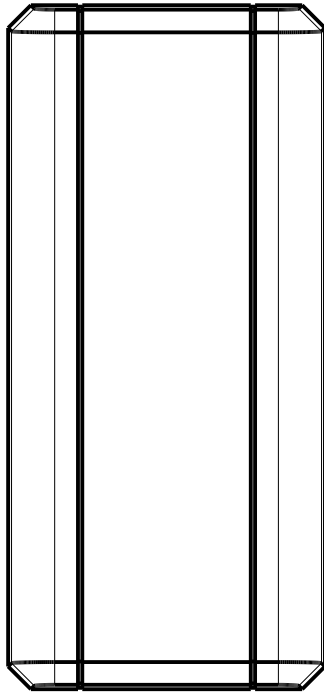

SCALE 0.750

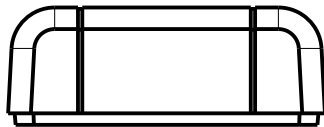
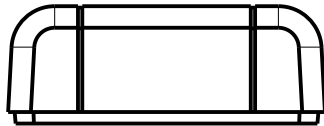
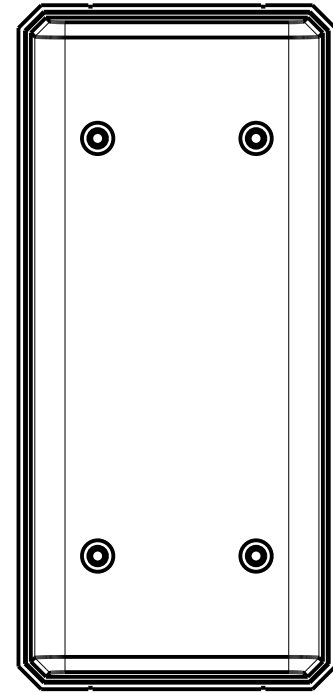
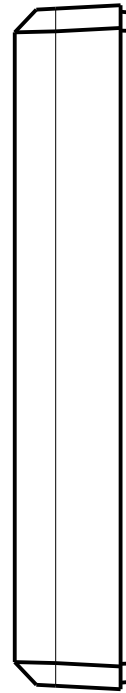
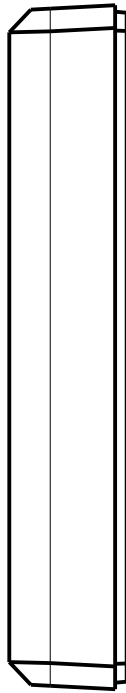

TOLERANCES: UNLESS OTHERWISE SPECIFIED
DIMENSIONS ARE IN U.S. INCHES.
X.XX = .015 X.XXXX = .001
X.XXX = .010 X.X° = 1°

NEW AGE ENCLOSURES

Customer's Part No: 472216

APPROVAL	BY	DATE
CHECK		
ENG.		
SCALE	AS NOTED	

DRAWN BY
M BOYER 2016-Mar-14

NEW AGE ENCLOSURES

4330 Santa Fe Road San Luis Obispo, CA. 93401
ph. (805) 595-1310 fax (805) 595-1024
www.newageenclosures.com

MEDIUM 3 AA - STANDARD
SXX-472216-XXX

SIZE A	DRAWING NAME 472216_RA	SHEET 3 OF 8	REV.DOC A
-----------	---------------------------	-----------------	--------------

472216 BASE

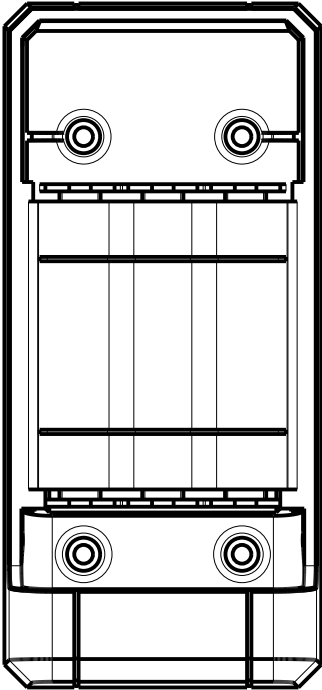

SCALE 0.750

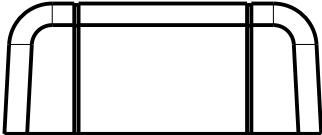
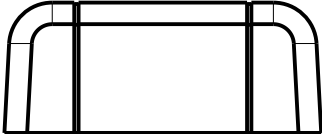
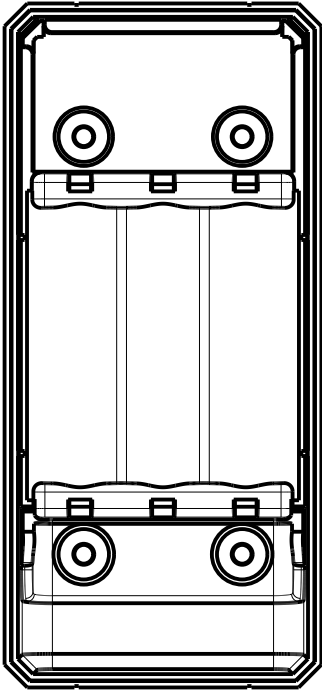
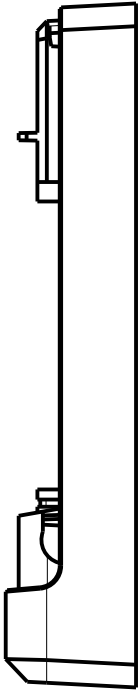

TOLERANCES: UNLESS OTHERWISE SPECIFIED
DIMENSIONS ARE IN U.S. INCHES.
X.XX = .015 X.XXXX = .001
X.XXX = .010 X.X° = 1°

NEW AGE ENCLOSURES

Customer's Part No: 472216

APPROVAL	BY	DATE
CHECK		
ENG.		
SCALE	AS NOTED	

DRAWN BY
M BOYER 2016-Mar-14

NEW AGE ENCLOSURES

4330 Santa Fe Road San Luis Obispo, CA. 93401
ph. (805) 595-1310 fax (805) 595-1024
www.newageenclosures.com

MEDIUM 3 AA - STANDARD
SXX-472216-XXX

SIZE A DRAWING NAME 472216_RA SHEET 4 OF 8 REV.DOC A

472216 HATCH

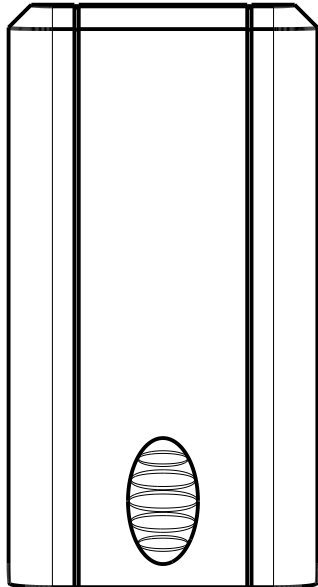
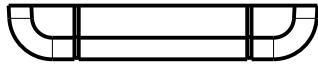

SCALE 0.750

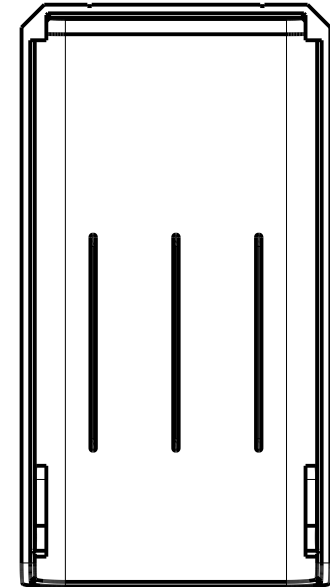
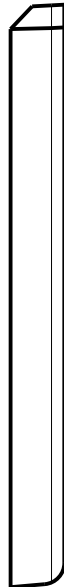

TOLERANCES: UNLESS OTHERWISE SPECIFIED
DIMENSIONS ARE IN U.S. INCHES.
X.XX = .015 X.XXXX = .001
X.XXX = .010 X.X° = 1°

NEW AGE ENCLOSURES

Customer's Part No: 472216

APPROVAL BY DATE

CHECK

ENG.

SCALE AS NOTED

DRAWN BY M BOYER 2016-Mar-14

NEW AGE ENCLOSURES

4330 Santa Fe Road San Luis Obispo, CA. 93401
ph. (805) 595-1310 fax (805) 595-1024
www.newageenclosures.com

MEDIUM 3 AA - STANDARD
SXX-472216-XXX

SIZE A	DRAWING NAME 472216_RA	SHEET 5 OF 8	REV.DOC A
--------	------------------------	--------------	-----------

472216 WALL

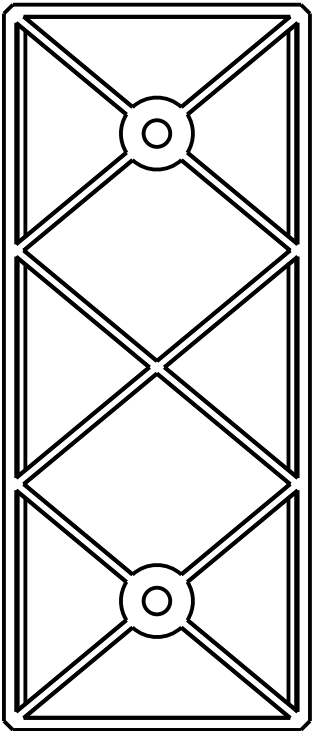
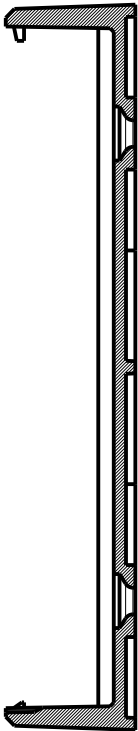
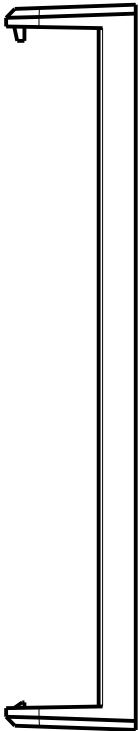
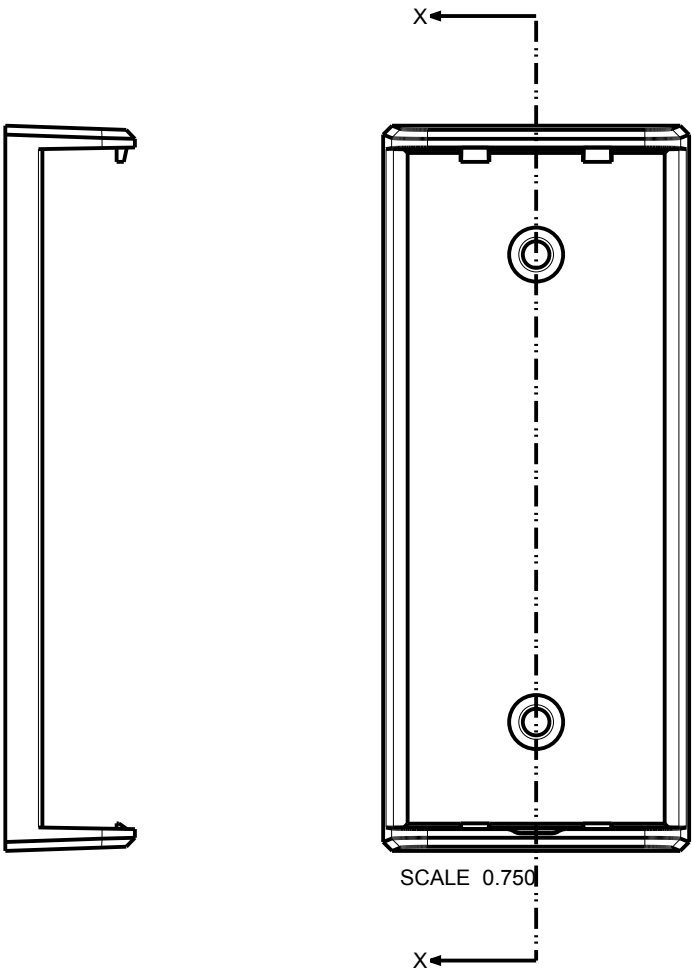

SECTION X-X



TOLERANCES: UNLESS OTHERWISE SPECIFIED
DIMENSIONS ARE IN U.S. INCHES.
X.XX = .015 X.XXXX = .001
X.XXX = .010 X.X° = 1°

NEW AGE ENCLOSURES

Customer's Part No: 472216

APPROVAL	BY	DATE
CHECK		
ENG.		
SCALE	AS NOTED	

DRAWN BY
M BOYER 2016-Mar-14

NEW AGE ENCLOSURES

4330 Santa Fe Road San Luis Obispo, CA. 93401
ph. (805) 595-1310 fax (805) 595-1024
www.newageenclosures.com

MEDIUM 3 AA - STANDARD
SXX-472216-XXX

SIZE A	DRAWING NAME 472216_RA	SHEET 6 OF 8	REV.DOC A
-----------	---------------------------	-----------------	--------------

472216 PCB



SCALE 0.750



TOLERANCES: UNLESS OTHERWISE SPECIFIED DIMENSIONS ARE IN U.S. INCHES. X.XX = .015 X.XXXX = .001 X.XXX = .010 X.X° = 1°		NEW AGE ENCLOSURES 4330 Santa Fe Road San Luis Obispo, CA. 93401 ph. (805) 595-1310 fax (805) 595-1024 www.newageenclosures.com			
Customer's Part No: 472216					
APPROVAL	BY	DATE	MEDIUM 3 AA - STANDARD SXX-472216-XXX		
CHECK					
ENG.					
SCALE	AS NOTED				
DRAWN BY	2016-Mar-14	SIZE	DRAWING NAME	SHEET	REV.DOC
M BOYER		A	472216_RA	7 OF 8	A

472216 2nd OPERATION

NEW AGE ENCLOSURES DELIVERS YOUR ENCLOSURE MARKET-READY WITH IN-HOUSE CNC MACHINING, PAD PRINTING, ASSEMBLY, AND FULFILLMENT. ALL SURFACES AND AREAS ARE AVAILABLE FOR CNC ALTERATION BY NEW AGE ENCLOSURES CALL (805) 595-1310 FOR PRICING AND SCHEDULE. THE INSIDE RADIUS OF ANY MACHINED FEATURES SHOULD BE NO SMALLER THAN .031"

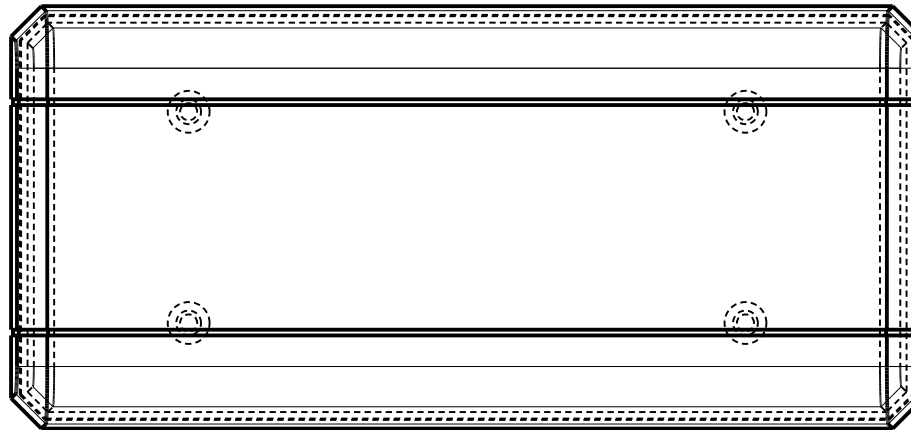
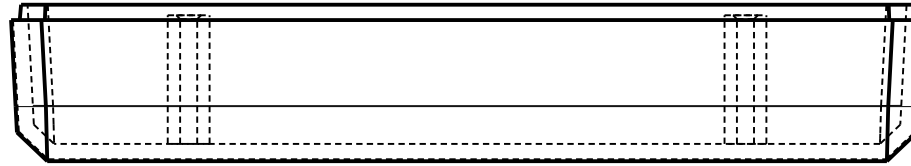

SCALE 1.000

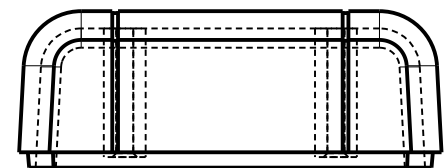
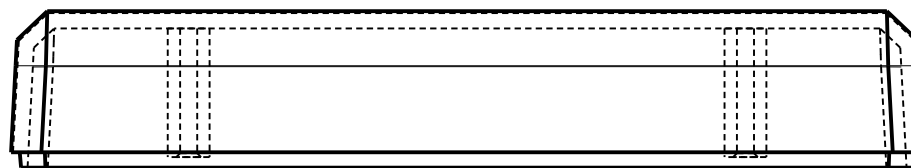
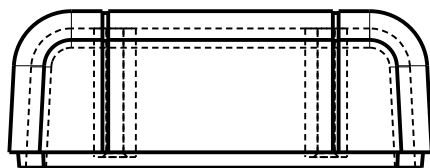

SXX-472216-XXX COVER - ABS, BLACK

STEP NO	DESCRIPTION	CUTTER	FIXTURE	ORIENTATION	PROGRAM
1-C-C1	-	T2 = .062" EM	XXX	-	o1001
2-C-C2	-	T2 = .062" EM	XXX	-	o1002

SXX-472216-XXX COVER - ABS, BLACK

STEP	TYPE	FIXTURE	INK COLOR	CLICHE DESCRIPTION	CLICHE No.
4-C-P1	PAD PRINT	XXX	WHITE	LOGO AND LABELS	CL1010 R1

TOLERANCES: UNLESS OTHERWISE SPECIFIED DIMENSIONS ARE IN U.S. INCHES.

X.XX = .015 X.XXXX = .001
X.XXX = .010 XX° = 1°

Customer's Part No: 472216

APPROVAL BY DATE
CHECK
ENG.

SCALE AS NOTED

DRAWN BY M BOYER 2016-Mar-14

NEW AGE ENCLOSURES

4330 Santa Fe Road San Luis Obispo, CA. 93401
ph. (805) 595-1310 fax (805) 595-1024
www.newageenclosures.com

MEDIUM 3 AA - STANDARD SXX-472216-XXX

SIZE A DRAWING NAME 472216_RA SHEET 8 OF 8 REV.DOC A